

TVS Diodes

Transient Voltage Suppression Diodes

SPC6 Series (6 kA)



Description

The SPC6 in SMT0-218 package provide the enhanced quality, easy manufacturing than typical through-hole TVS components. They can be connected in series and/or parallel to create various capability and flexible protection solutions.

Functional Diagram

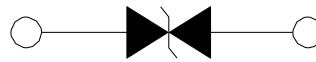

Bi-Directional

Applications

- Communication Equipment
- Security & Protection
- Industrial Control Equipment
- Power Supply
- Automotive Electronics
- New Energy
- Surge Protection

Features

- Bi-directional
- Low clamping and slope resistance
- For automatic pick and place assembly and reflow process to reduce the manufacturing cost and increase the soldering quality compared to axial leads package
- Compact surface mount package design
- Meet MSL level 1, per J-STD-020, LF Maximum peak of 245 °C
- Pb-free E3 means 2nd level interconnect is Pb-free and the terminal finish material is tin (Sn)
- ESD follow IEC 61000-4-2
- Surge protection of lightning in accordance with IEC61000-4-5
- Halogen free and RoHS compliant
- Tube or tape and reel pack options available

TVS Diodes

Transient Voltage Suppression Diodes

SPC6 Series (6 kA)

Package Outline Dimensions (SMTO-218)

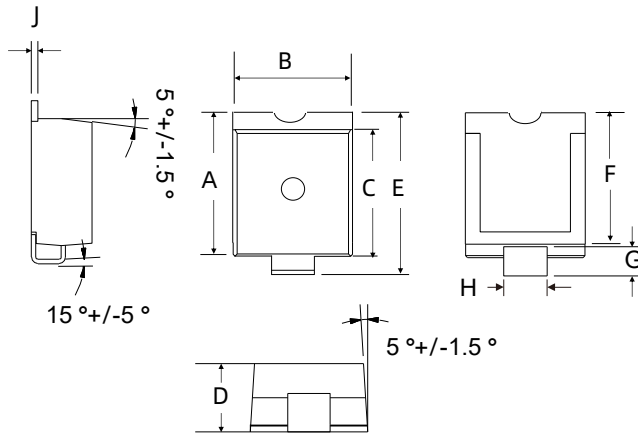

Note: Coplanarity of solder side is controlled within 0.10 mm

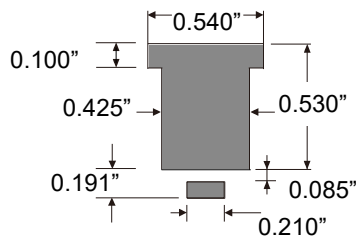

Mounting Pad Layout (Inch)

Symbol	Millimeters		Inches	
	Min.	Max.	Min.	Max.
A	15.78	16.63	0.621	0.655
B	13.43	15.09	0.529	0.594
C	13.83	14.24	0.544	0.561
D	6.94	7.24	0.273	0.285
E	17.82	18.72	0.702	0.737
F	14.40	14.76	0.567	0.581
G	1.88	2.84	0.074	0.112
H	4.89	5.65	0.193	0.222
J	0.72	0.85	0.028	0.033

Maximum Ratings and Characteristics

(Ratings at 25 °C ambient temperature unless otherwise specified.)

Parameter	Symbol	Value	Unit
Storage Temperature Range	T _{STG}	-55 to 150	°C
Operating Junction	T _J	-55 to 125	°C
Current Rating (8/20 μs wave)	I _{PP}	6	kA

Physical Specifications

Weight	Contact manufacturer
Case	Epoxy molding compound encapsulated
Terminal	Tin plated lead, solderability per MIL-STD-202 Method 208

TVS Diodes

Transient Voltage Suppression Diodes

SPC6 Series (6 kA)

Environmental Specifications

Temperature Cycling	JESD22-A104
HTRB	JESD22-A108
MSL	JESDEC-J-STD-020, Level 1
H3TRB	JESD22-A101
RSH	JESD22-B106

Part Numbering System

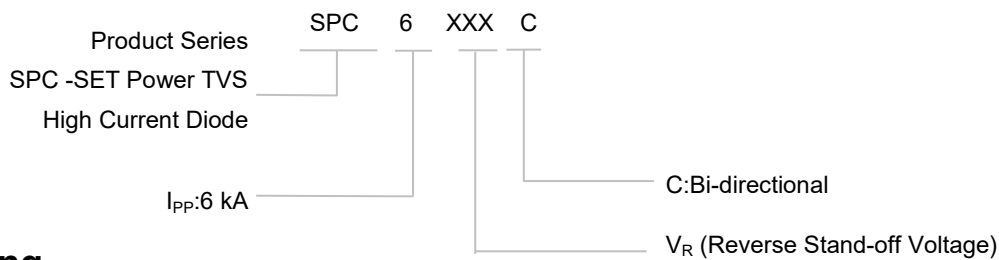

Marking

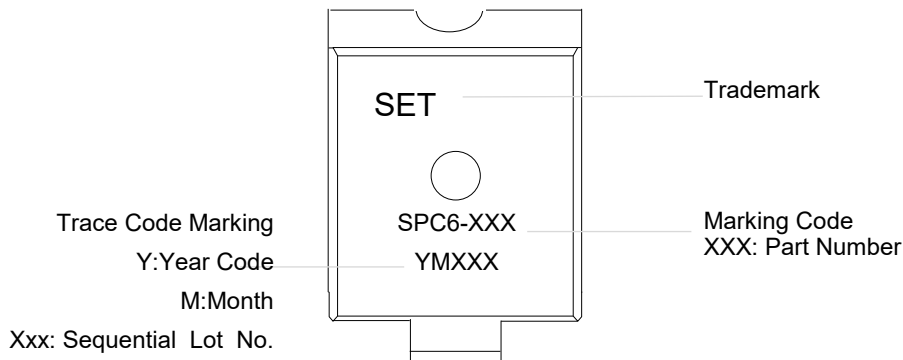

Electrical Characteristics $(T_A=25\text{ }^\circ\text{C}$ unless otherwise noted)

Part Number	Stand-off Voltage V_R	Max. Reverse Leakage $I_R@V_R$	Breakdown Voltage $V_{BR}@I_T$		Test Current I_T	Max. Clamping Voltage V_{CL} @Peak Pulse Current (I_{PP})			Max. Temp Coefficient of V_{BR}	Max. Capacitance 0 Bias 10KHz
			Min	Max		V_{CL}	I_{PP}			
							Min	Typical		
(V)	(μ A)	(V)		(mA)	(V)	(A)	(A)	(%/°C)	(nF)	
SPC6-058C	58	10	64	70	10	110	6000	900	0.1	6.5
SPC6-066C	66	10	72	80	10	120	6000	900	0.1	5.5
SPC6-076C	76	10	85	95	10	140	6000	900	0.1	4.5

TVS Diodes

Transient Voltage Suppression Diodes

SPC6 Series (6 kA)

I-V Curve Characteristics

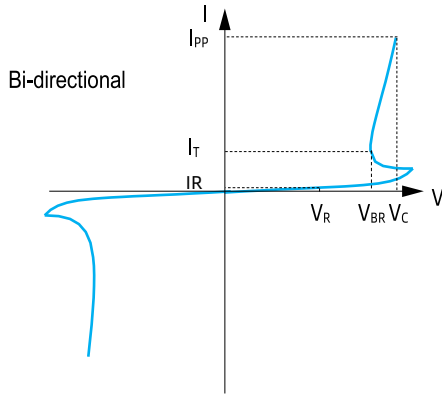

Performance Curve for Reference ($T_A=25^\circ\text{C}$ unless otherwise noted)

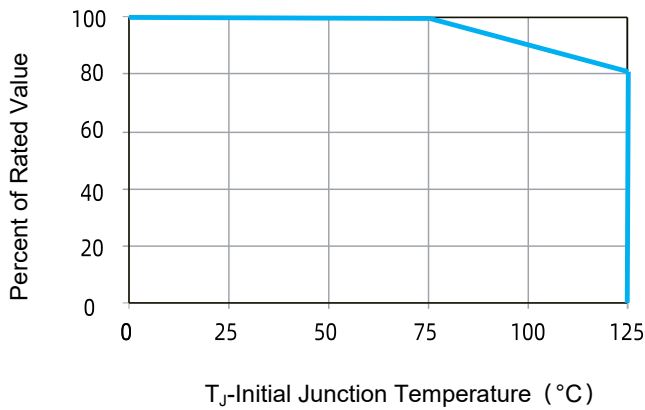

FIGURE 1 Peak Power Derating

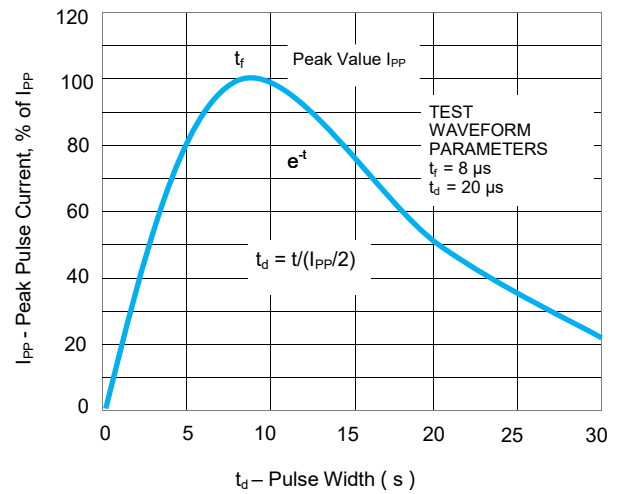

FIGURE 2 Pulse Waveform

TVS Diodes

Transient Voltage Suppression Diodes

SPC6 Series (6 kA)

Soldering Parameters

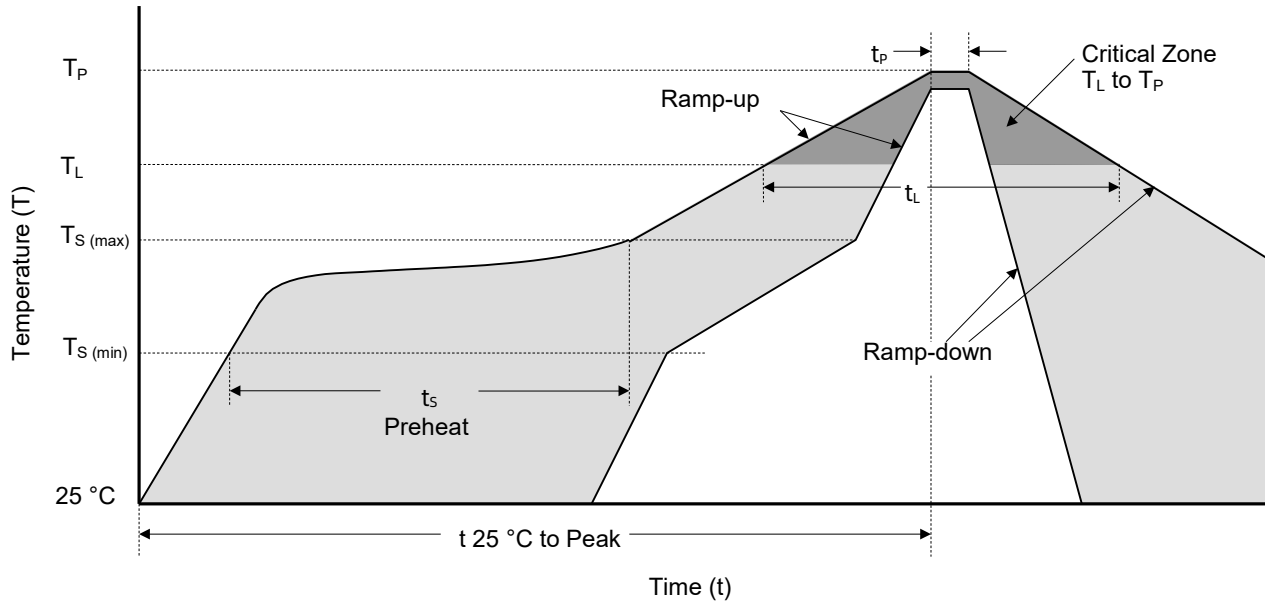

Reflowing Condition

Reflow Soldering Parameters		Lead-Free Assembly
Pre-heat	Temperature Min ($T_{S (min)}$)	150 °C
	Temperature Max ($T_{S (max)}$)	200 °C
	Time (min to max) (t_s)	60 ~ 120 seconds
Average Ramp Up Rate (Liquidus Temp (T_L) to Peak)		3 °C / second max.
$T_S (max)$ to T_L Ramp-up Rate		3 °C / second max.
Reflow	Temperature (T_L) (Liquidus)	217 °C
	Time (min to max) (t_L)	60 ~ 150 seconds
Peak Temperature (T_P)		245 ^{+0/-5} °C
Time of within 5 °C of Actual Peak Temperature (t_p)		20 ~ 40 seconds
Ramp-down Rate		6 °C / second max.
Time from 25 °C to Peak Temperature		8 Minutes max.
Do Not Exceed		245 °C

Wave Soldering (Solder Dipping)

Peak Temperature	260 °C+0 /- 5 °C
Dipping Time	10 seconds
Soldering Number	1 time

TVS Diodes

Transient Voltage Suppression Diodes

SPC6 Series (6 kA)

Packaging Information

Tape		Symbol	Millimeters	Inches
		W	32±0.3	1.260±0.012
		E	1.75±0.1	0.069±0.004
		F	14.2±0.1	0.559±0.004
		D ₀	1.5+0.1/0.0	0.059+0.004/-0.0
		P ₀	4.0±0.1	0.102±0.004
		P ₁	20.0±0.1	0.787±0.004
		P ₂	2.0±0.1	0.079±0.004
		A ₀	14.5±0.1	0.571±0.004
		B ₀	18.5±0.1	0.728±0.004
		T	0.40	0.016
T ₁	7.8	0.029		

Reel Size		Symbol	Inches	Millimeters
		D	Φ13.0	Φ330.0
		D ₁	Φ0.520±0.008	Φ13.2±0.2
		W ₁	1.417±0.079	36.0±2.0

Part Number	Weight (Typical)	Packaging Option	QTY' s
SPC6-XXXXC	4.33 g	Tape & Reel – 32mm/13" tape	400 PCS

Glossary

Item	Description
V_C	Clamping Voltage Voltage across TVS in a region of low differential resistance that serves to limit the voltage across the device terminals.
V_R	Reverse Stand-off Voltage Maximum voltage that can be applied to the TVS without operation. NOTE : It is also shown as V_{WM} (maximum working voltage (maximum d.c. voltage)) and known as rated stand-off voltage (V_{so}).
I_R	Reverse Leakage Current Current measured at V_R . NOTE : Also shown as I_D for stand-by current.
V_{BR}	Breakdown Voltage Voltage across TVS at a specified current I_T in the breakdown region.
I_{PPM}	Rated Random Recurring Peak Impulse Current Maximum-rated value of random recurring peak impulse current that may be applied to a device.
$P_{M(AV)}$	Rated Average Power Dissipation Maximum-rated value of power dissipation resulting from all sources, including transients and standby current, averaged over a short period of time.
P_{PPM}	Rated Random Recurring Peak Impulse Power Dissipation Maximum-rated value of the product of rated random recurring peak impulse current (I_{PPM}) multiplies by specified maximum clamping voltage (V_C).
C_J	Capacitance Capacitance across the TVS measured at a specified frequency and voltage.
V_{FS}	Peak Forward Surge Voltage Peak voltage across an TVS for a specified forward surge current (I_{FS}) and time duration. NOTE : Also shown as V_F .
I_{FS}	Forward Surge Current Pulsed current through TVS in the forward conducting region. NOTE : Also shown as I_F .
$\alpha_{V(BR)}$	Temperature Coefficient of Breakdown Voltage The change of breakdown voltage divided by the change of temperature.
I_{PP}	Peak pulse Current Peak pulse current value applied across the TVS to determine the clamping voltage V_C for a specified wave shape.
I_T	Pulsed D.C. Test Current Test current for measurement of the breakdown voltage V_{BR} . This is defined by the manufacturer and usually given in milliamperes with a pulse duration of less than 40 ms. NOTE : Also shown as I_{BR} .

—(GB-T 18802.321 / IEC 61643-321 / JESD210A)



ATTENTION

Usage

1. TVS must be operated in the specified ambient temp.
2. Do not clean the TVS with strong polar solvent such as ketone, esters, benzene and halogenated hydrocarbon, to avoid damaging the encapsulating layer.
3. Please do not apply severe vibration, shock or pressure to TVS, to avoid element cracking.

Replacement

1. If TVS is visually damaged, please replace it.
2. TVS is a non-repairable product. For safety sake, please use equivalent TVS for replacement.

Storage

1. Storage Temp. Range: (-55 to 150) °C.
2. Do not store the TVS at the high temp., high humidity or corrosive gas environment, to avoid influencing the solder- ability of the lead wires. The product shall be used up within 1 year after receiving the goods.

Environmental Conditions

1. TVS should not be exposed to the open air, nor direct sunshine.
2. TVS should avoid rain, water vapor or other condition of high temp. and high humidity.
3. TVS should avoid sand dust, salt mist, or other harmful gases.

Max. Typical Capacitance of TVS

The typical capacitance of TVS is listed in the specifications. Designers may refer to it when designing TVS in High frequency circuit.

Installation Mechanical Stress

1. Do not knock TVS when installing, to avoid mechanical damage.
2. Please do not apply severe vibration, shock or pressure to TVS, to avoid surface resin or element cracking.